

MODEL OPC12, OPC15, AND OPC24 MANUAL

FOR CANON MEDICAL

Table of Contents

HASKRIS CONTACT INFORMATION	5
NORMAL BUSINESS HOURS.....	5
AFTER HOURS URGENT SUPPORT	5
INSTALLATION: CONFIRM MRI MODEL AND HASKRIS CHILLER MODEL	6
MRI MODEL.....	6
CHILLER MODEL.....	6
MODIFIED CHILLER MODELS.....	6
INSTALLATION: FOUNDATION, VIBRATION, ELEVATION, CLEARANCES, TRANSPORTATION	7
FOUNDATION	7
VIBRATION	10
ELEVATION DIFFERENCE	11
CLEARANCES.....	11
TRANSPORTATION	14
INSTALLATION: LINE SIZING, PIPING	15
LINE SIZING.....	15
PIPING.....	16
INSTALLATION: ELECTRICAL, REMOTE CONTROL PANEL, CONNECTION TO INDOOR HEAT EXCHANGER ...	18
ELECTRICAL	18
REMOTE CONTROL PANEL.....	20
CONNECTION TO INDOOR HEAT EXCHANGER.....	22
INSTALLATION: PIPING FLUSH, PURGE, GLYCOL MIXTURE, FILLING	23
PIPING FLUSH	23
PIPING PURGE.....	23
GLYCOL MIXTURE.....	24
FILL THE RESERVOIR.....	25
FILL THE PIPING	25
INSTALLATION: FINAL CHECKS	26
PHASE MONITOR.....	26
CONTROLLER FAULTS.....	26
PRE-STARTUP CHECKLIST	27

OPTIONAL MODBUS OR BACNET COMMUNICATION CAPABILITY	29
BUILDING MANAGEMENT SYSTEM	29
HASKRIS CAPABILITY	29
IMPLEMENTATION	29
PHYSICAL CONNECTION	30
SETTINGS CONFIGURATION	30
BAUD RATE SUPPORT	31
A2L REFRIGERANT SUPPLEMENTAL MANUAL	32
STARTUP	33
PHASE MONITOR	33
ON/OFF SWITCH	35
PUMP PRIMING	36
PUMP SUPPLY PRESSURE	37
PUMP ROTATION DIRECTION	38
CONTROLLER DISPLAY	39
MAIN DISPLAY	39
ADJUSTING SET VALUE (SV)	40
UNITS OF MEASURE	40
FAULTS	42
ACCESS SERVICE MENU	44
LOGOUT OF SERVICE MENU	45
CAPABILITIES IN THE SERVICE MENU	45
OBSERVE DETAILED REFRIGERATION DATA OR FORCE A SPECIFIC CIRCUIT TO RUN	46
CHILLER FEATURES	48
CELLULAR COMMUNICATION AND REMOTE MONITORING	48
LOCAL MONITORING AND REMOTE CONTROL PANEL	48
SEPARATE INDEPENDENT REFRIGERATION CIRCUITS	49
E-COATED CONDENSERS FOR CORROSION RESISTANCE	49
ENERGY SAVING ECO MODE	49
DYNAMIC CAPACITY CONTROL	50

MAINTENANCE.....	51
FREQUENCY	51
GLYCOL MIXTURE.....	51
WYE STRAINER	51
CONDENSER COILS.....	52
ELECTRICAL INSPECTION	52

Haskris Contact Information

Normal Business Hours

Contact Haskris with any questions about a unit and/or the information in this manual. Haskris has a team of engineers available to answer questions, troubleshoot issues, or provide supplemental information as needed.

Please have the serial number of the Haskris unit so we can provide prompt assistance.

Availability: Monday through Friday 8:30am to 5:30pm (central US time)

Phone: 001 847 956 6420

Email: service@haskris.com or sales@haskris.com

After Hours Urgent Support

Details: Outside of normal Haskris business hours, Haskris engineers can be reached for urgent support.

Applicability: This support applies for chillers during the warranty period or for chillers that have an active, paid full service and maintenance contract through Canon and/or Haskris.

Availability: Monday thru Friday 5:30pm to 8:30am (central US time) and 24/7 Saturday thru Sunday

Phone: 001 847 279 4955

Installation: Confirm MRI Model and Haskris Chiller Model

MRI Model

Details: Confirm the MRI model and confirm the gradient coil version (if applicable). Contact Canon for assistance.

Chiller Model

Details: Haskris provides several chiller models for cooling Canon MRIs. Use the MRI and gradient coil information to identify the appropriate chiller model. These instructions include applicable information for each model.

Canon MRI Model	Haskris Chiller Model
Galan	OPC24
Orian STD/XGO	
Orian STD	OPC15
Fortian	
Elan	OPC12

Modified Chiller Models

Details: In some cases, a modified chiller may be provided by Haskris. This is done in exceptional situations to mitigate risks of site locations with certain limitations. These modifications can include but are not limited to:

- Alternative dimensions
- Alternative electrical designs
- Alternative air flow configurations

Consult Haskris if there are questions about the capabilities, requirements, or design intention of a specific unit.

Installation: Foundation, Vibration, Elevation, Clearances, Transportation

Foundation

- Comply with all local codes for proper anchoring and vibration isolation.
- The chiller must be installed on a level foundation.
- The foundation may be concrete, roof curb, or perimeter beam system depending on the needs of the site.
- Use of a level roof curb or perimeter beam system requires the specifying engineer to identify all necessary materials of construction, thickness, and additional bracing or supports.
- The chillers are built on a base and the base has a mounting flange along the long sides of the chiller. The whole span of the mounting flange must be supported by the foundation.
- See the diagrams below for mounting hole locations.
- Point load at each mounting location is 200 lbs. or less.

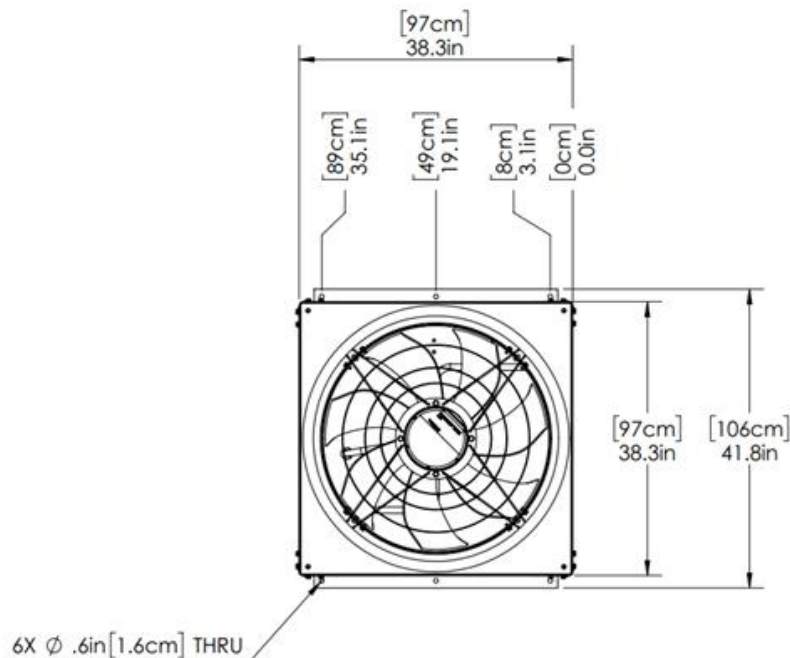

Mounting Hole Locations for Non-OSHPD Sites – OPC12, OPC15

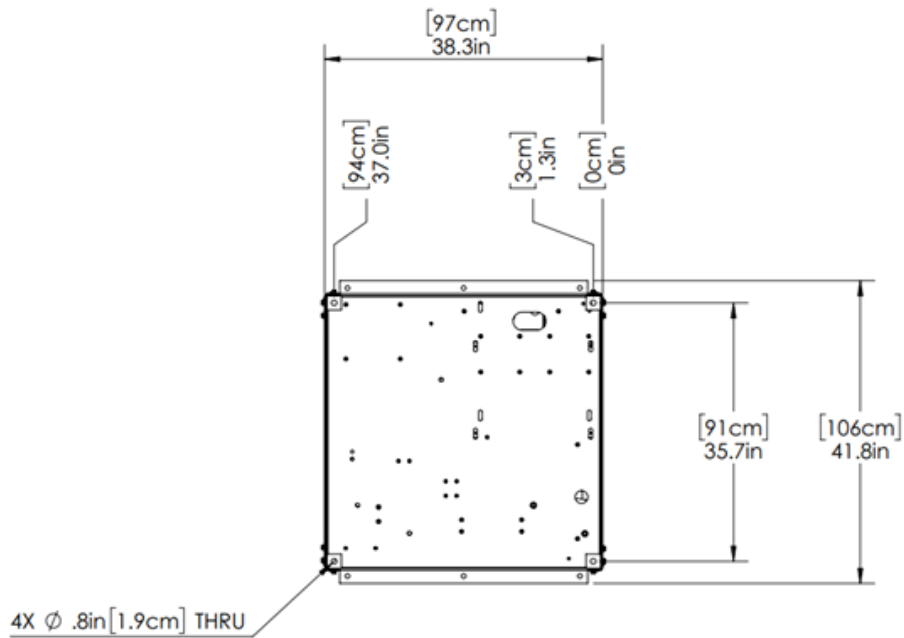

Mounting Hole Locations for OSHPD Sites – OPC12, OPC15

Seismic SDS level 1: IP=1.5; SDS=2.00g for z/h=1 & SDS=2.50g for z/h=0

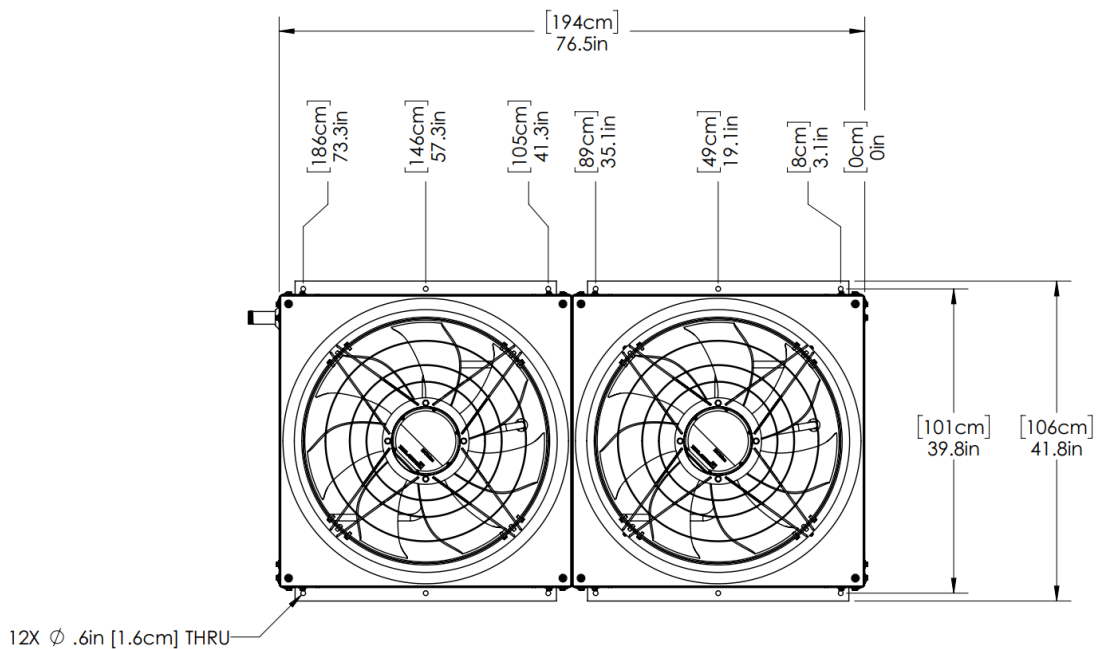

Mounting Hole Locations for Non-OSHPD Sites – OPC24

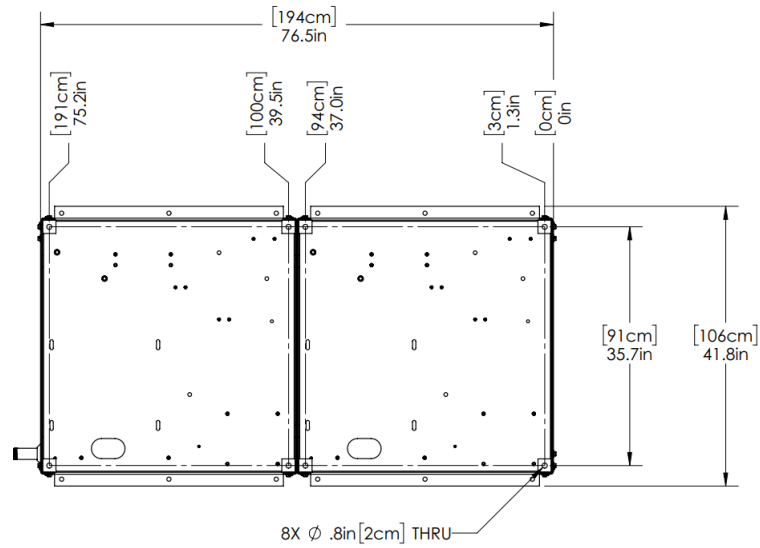

Mounting Hole Locations for OSHPD Sites – OPC24

Seismic SDS level 1: IP=1.5; SDS=2.00g for z/h=1 & SDS=2.50g for z/h=0

Vibration

- The chiller does not require vibration isolation on the mounting for the chiller to operate normally.
- The motors in the chiller are hard mounted to the metal structure of the chiller. They are not internally isolated.
- It is common for the chiller to be hard mounted directly to a pad on grade, roof curb, or perimeter beam system.
- If vibration transmission to the building structure is a concern, an engineer should provide a detailed specification for vibration damping.
- There are two common approaches
 - Rubber or synthetic pads between the chiller and the mounting
 - Spring vibration isolators. These cannot be installed directly between the chiller and the mounting. The chiller must be mounted on a perimeter beam. The spring vibration isolators can be installed between the beam and the mounting.

OSHPD: If OSHPD compliance is required and isolators are used, the spring isolators must comply with Haskris OSHPD OSP-0673 file.

Brands: Mason Industries and BRD Noise and Vibration control both make good products for vibration isolation.

Elevation Difference

For chillers located at a *higher* elevation than the MRI

- The maximum recommended height difference is 70 ft (21.3 m).
 - The maximum height difference is based on several factors including the maximum inlet water pressure for the MRI, normal water pump discharge pressure, and pressure losses in the piping to the MRI.
 - Consult Haskris if there are questions or if additional analysis is needed.

For chillers located at a *lower* elevation than the MRI

- It is best if the height difference can be less than 32 ft (9.8 m).
 - This height difference corresponds to approximately 1 atm of pressure.
 - The reservoir in the Haskris chiller is closed but not sealed. It is open to atmospheric pressure.
 - Limiting the height difference ensures that atmospheric pressure on the fluid in the reservoir can suspend the recirculating fluid in the external piping.
- Consult Haskris if there are questions or if additional analysis is needed.

Clearances

Purpose: Clearance specifications serve two purposes. Proper clearances ensure fresh air flow through the air-cooled condensers for heat rejection to ambient air. Proper clearances ensure access for service and maintenance activities.

- See the diagrams below showing recommended clearances.
- Air flow is horizontal into the chiller and vertical out of the chiller.
- Maintain an unobstructed space for free air discharge above the chiller.
- Consult Haskris if clearances will be smaller than these recommendations. Haskris will evaluate individual site conditions as needed to ensure proper operation.
- Avoid areas where a heat source will discharge heat towards the chiller.
 - Examples: condenser vents, heating exhaust, etc.
- Avoid areas where debris may accumulate on the condenser.

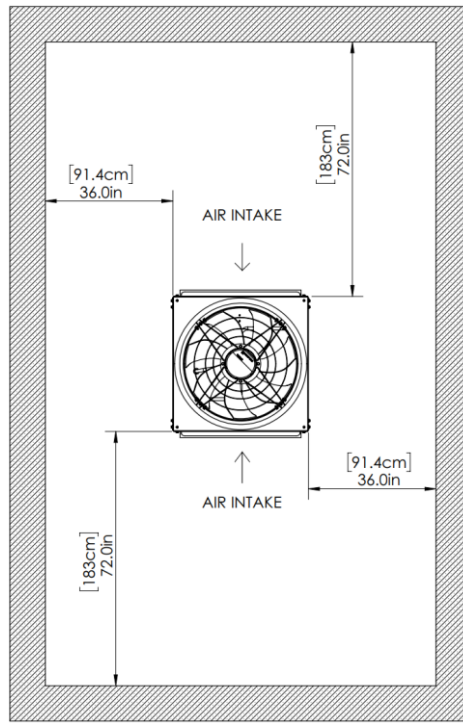

Clearance Recommendations – OPC12

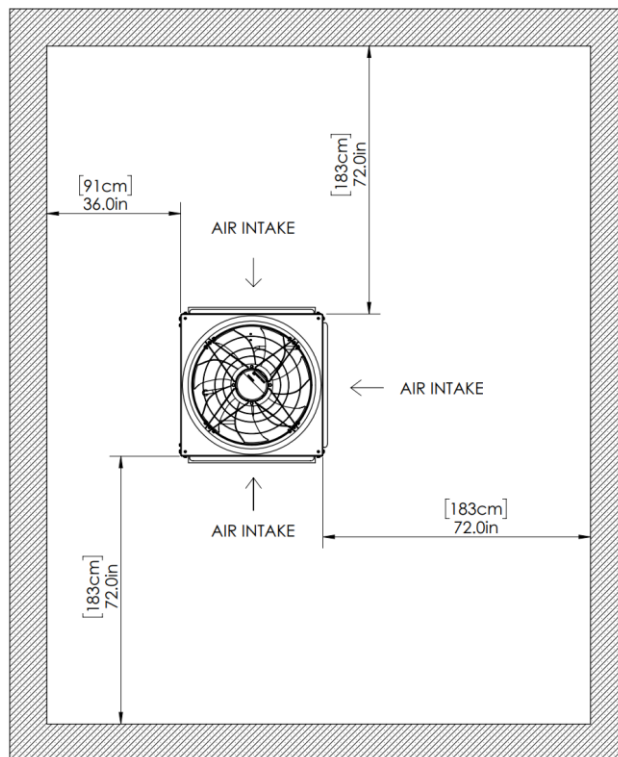

Clearance Recommendations – OPC15

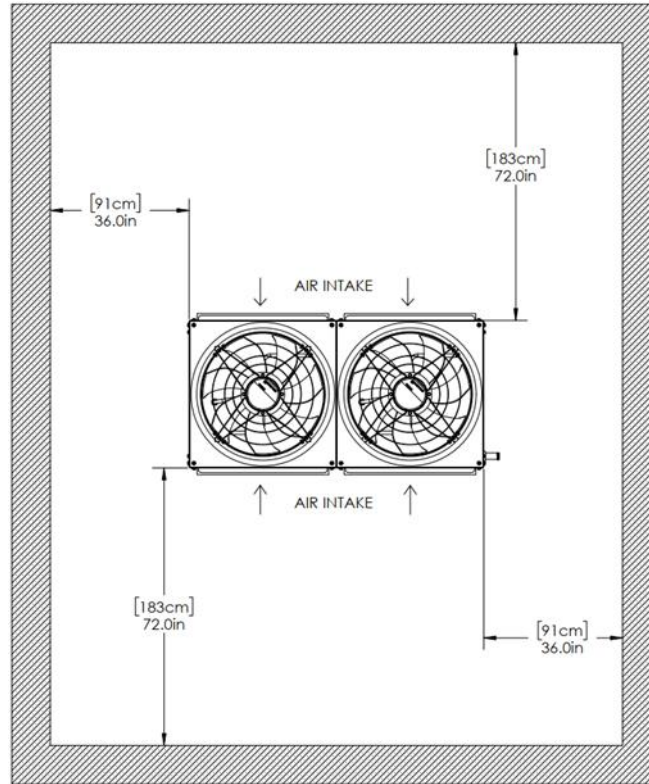

Clearance Recommendations – OPC24

Transportation

- Transport the chiller using the fork pockets or rigging lift points. Ensure forks are past the chiller center post.
- If rigging the chiller, lift only from the points shown below. Proper rigging technique, including spreader bars, is critical to avoid damaging the chiller.
- Do not remove any panels from the chiller during the rigging process.
- See below for rigging points.

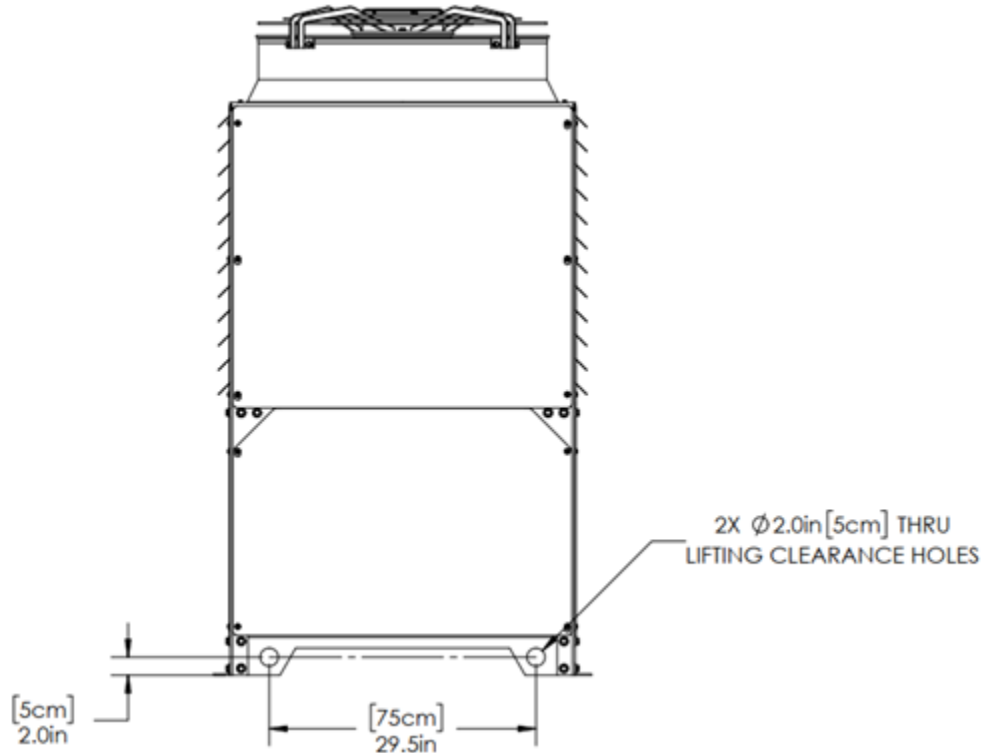

Installation: Line Sizing, Piping

Line Sizing

Call Haskris for help: Haskris is available to review pipe runs, pressure drop, etc. and make recommendations for individual sites.

- If the total straight pipe length is less than 375 ft (114.3 m) use 1-1/2" nominal pipe size (ID).
- If the total straight pipe length is less than 1,400 ft (426.7 m) use 2" nominal pipe size (ID).
- If the total straight pipe length is greater than 1,400 ft (426.7 m) consult Haskris for assistance.

Piping

- Comply with all local codes for proper piping.
- Use type L copper piping and non-ferrous materials.
 - Do not use black steel, cast iron, or other similar piping materials.
 - PVC or CPVC piping materials have "fair" or "not resistant" chemical compatibility with propylene glycol. This means that PVC or CPVC may weaken, soften, and/or swell over time. Haskris does not recommend using PVC or CPVC piping with propylene glycol. Contact Haskris for further information.
- Insulate external piping.
- Terminate the beginning and ends of hard runs with flexible connectors or vibration isolators.
 - Do not use any products containing black steel, cast iron or similar piping materials.
- Ensure piping is clean and free of flux at solder joints.
- Install manual ball valves at high points in the piping to facilitate purging air while filling the lines.
 - Automatic purge valves may be used, but isolation ball valves must be installed before the purge valves.
 - Purge valves must be closed during normal operation.
 - This ensures the piping can be fully sealed from atmospheric pressure.
- Install drain valves at the base of every rise for emptying the lines.
- Install a heat trace on piping exposed to temperatures below +20°F (-6.7°C).
 - Cover heat trace with closed cell UV resistant insulation.
 - Power the heat trace from a dedicated disconnect.
 - Heat trace is specified to provide additional protection against freezing in a scenario where the chiller loses power during extremely cold ambient conditions for an extended period of time.
- Label supply and return lines over insulation with arrows indicating flow directions.
- Install isolation ball valves on inlet and outlet connections near the MRI cooling cabinet.
- Install isolation ball valves on the supply and return connections at the chiller.
- Install flush ports with isolation valves after the supply and return ball valves.
- Sleeve and insulate pipe penetrations through all roof and/or walls.
- Install a loop of reinforced opaque hose between supply and return connections in equipment room for flushing.
- After the lines are flushed, connect the lines in the equipment room to the indoor heat exchanger.

Devices that are not recommended: Haskris does not recommend that any of the following are used in the piping system.

- Chemical feeder systems
- Expansion tanks
- Electronic regulation or shut off valves

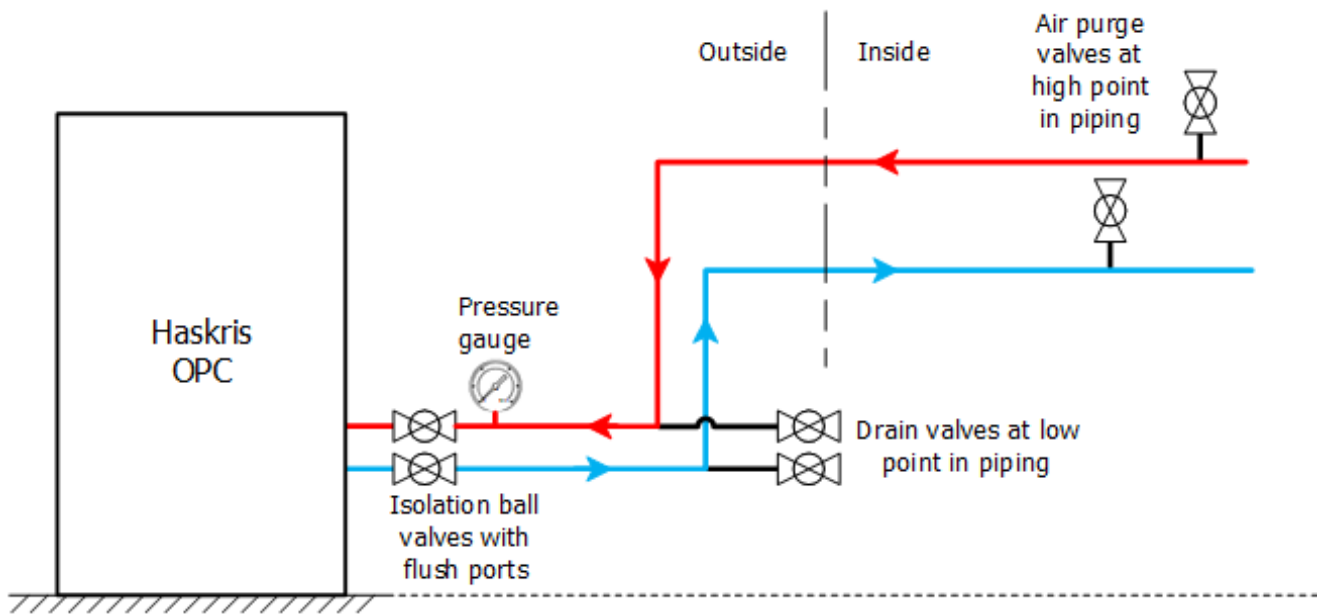

Piping Drawing

Installation: Electrical, Remote Control Panel, Connection to Indoor Heat Exchanger

Electrical

- Comply with proper local electrical codes.
- Contact a licensed electrician to perform the electrical installation.
- See the applicable Haskris cut sheets and/or chiller nameplate label for electrical ratings.
- The electrician should verify that the wiring is adequate in the installation area.
- Do not mount or support any electrical service disconnect directly to the chiller.
- Use flexible conduit from service panel disconnect through pilot hole to main electrical panel.
- Do not use rigid conduit at chiller.
- The base of the chiller has several openings where incoming electrical can be brought into the chiller.

Electrical connection: Use a dedicated service disconnect and time delay circuit protection (fusing or circuit breaker). Connect incoming electrical to L1, L2, L3 on the distribution block in the main electrical box.

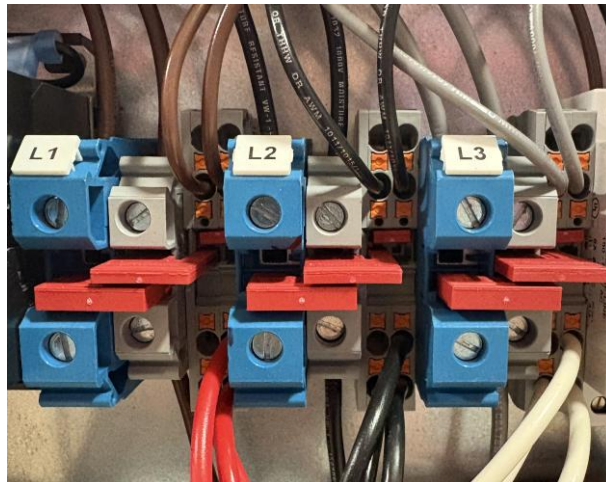
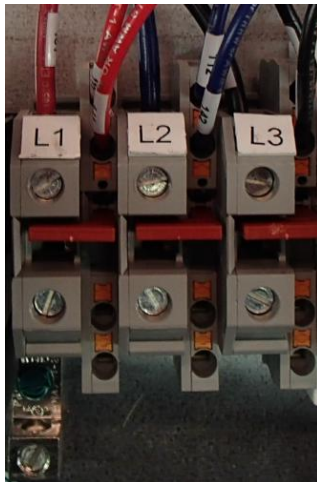

Energizing the service: Electrical power must be applied to the chiller at least 12 hours in advance of start-up. This energizes the crankcase heater and drives out any accumulated liquid refrigerant in the compressor.

Phase monitor: A phase monitor is built into the chiller. This checks that incoming voltage, phase sequence, and other electrical characteristics are correct.

Phase monitor type 1 has blue adjustment knobs and a single indicator light. Refer to the fault indicators provided on the phase monitor and contact a licensed electrician to correct any faults.



LED STATUS	STATUS
GREEN	NORMAL (RELAY ON)
GREEN	RESTART (DELAY)
RED	REVERSAL
RED	LOSS/UB (UNBALANCE)
RED	LOW VOLT (UNDERVOLTAGE)
RED	HIGH VOLT (OVERVOLTAGE)

Phase monitor type 2 has screen that displays line-line voltages across all 3 pairs of incoming electrical power.



Remote Control Panel

Purpose: The remote control panel is an identical mirror of what is displayed on the chiller's built-in controller. This allows the user to see the status and details of the chiller without going outdoors or opening the electrical boxes.



Location: The control panel is shipped inside the chiller near the pumps. The provided cable is also inside the chiller.

Installation: Mount the remote control panel on a wall indoors. See the templates on the next page.

Standard cable length: Standard chillers include a 150 ft (45.7 m) cable to connect this remote control panel with the outdoor chiller. Use the RJ12 plug provided on the cable to connect the remote control panel to the outdoor chiller.

Non-standard cable length: Optionally, some chillers may include a cable longer than 150 ft (45.7 m). In this case, the remote control panel is mounted on an electrical box. Connect the three wires on the cable to #2 (GND), #3 (TX -), and #4 (RX +) inside the box. Use the provided power cord and plug to connect the box to 115V electrical from a wall outlet.

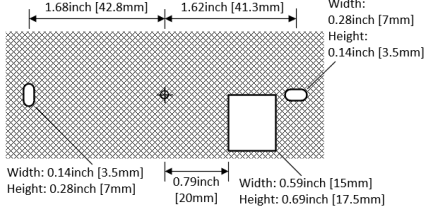
Cable rating: The cable provided by Haskris is CMX rated.

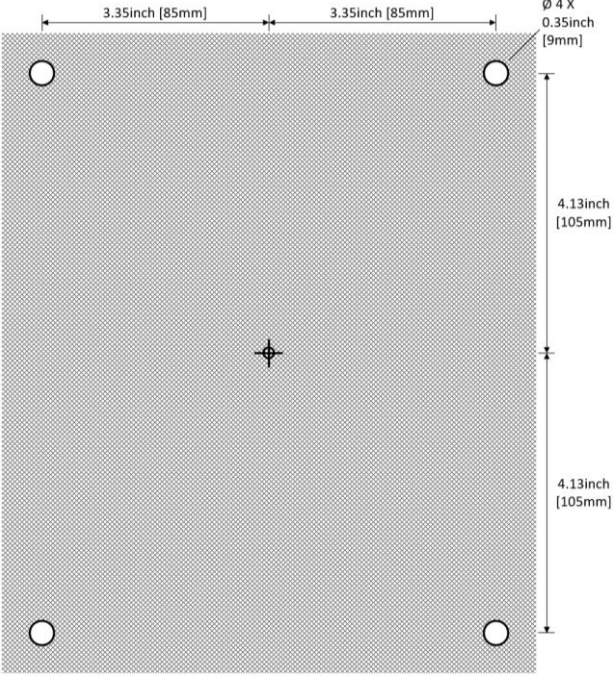
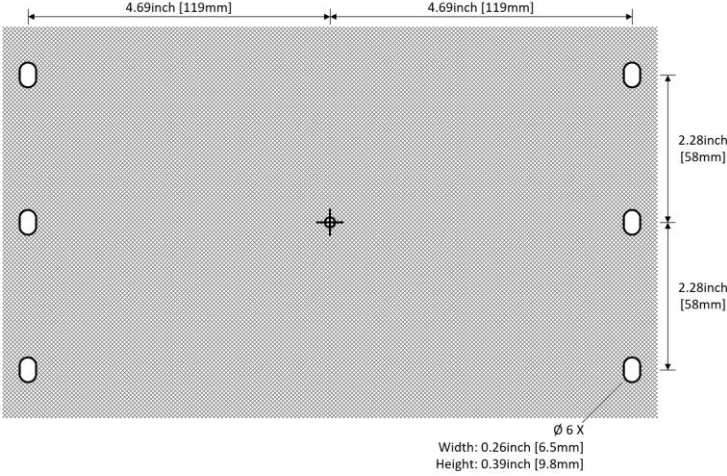
Distance Between Chiller & Panel	Remote Control Panel	Template for Mounting
<p>≤ 150ft ≤ 46m</p>		 <p>1.68inch [42.8mm] 1.62inch [41.3mm] Width: 0.28inch [7mm] Height: 0.14inch [3.5mm]</p> <p>Width: 0.14inch [3.5mm] Height: 0.28inch [7mm] 0.79inch [20mm] Width: 0.59inch [15mm] Height: 0.69inch [17.5mm]</p>
<p>≤ 500ft ≤ 152m</p> <p><i>* This is an optional feature at additional cost</i></p>		<p>Type I</p>  <p>3.35inch [85mm] 3.35inch [85mm] Ø 4 X 0.35inch [9mm]</p> <p>4.13inch [105mm]</p> <p>4.13inch [105mm]</p> <p>Type II</p>  <p>4.69inch [119mm] 4.69inch [119mm]</p> <p>2.28inch [58mm]</p> <p>2.28inch [58mm]</p> <p>Ø 6 X Width: 0.26inch [6.5mm] Height: 0.39inch [9.8mm]</p>

Connection to Indoor Heat Exchanger

Purpose: Some chiller systems come with a Haskris indoor heat exchanger, model WW3 or WW4. For these systems, wiring the OPC to the WW3 or WW4 ensures that Haskris will get remote notifications of heat exchanger faults.

Installation: Refer to the WW installation instructions for details.

Installation: Piping Flush, Purge, Glycol Mixture, Filling

Piping Flush

Purpose: It is common for the construction process to leave debris in the piping between the chiller and the MRI. This must be cleaned out of the piping prior to startup.

To flush the piping, follow procedure below.

1. Close supply and return ball valves.
2. Remove caps from flush ports and connect external water hose to each flush port.
3. Flush piping with external water until water runs clear.
4. Close return side flush valve and apply 100 psi gas for 30 minutes to check for leaks.
5. Repair any leaks and perform flush again.

Piping Purge

Purpose: The piping should be purged of the fluid used for the flush. This ensures a clean piping system that is not contaminated.

To purge the piping, follow procedure below.

1. After a successful leak check, open all drains including those installed on piping rise.
2. Use compressed air or nitrogen to eliminate water from lines.
3. Close all drains and purge isolation valves.

Glycol Mixture

Purpose: Glycol is required to resist freezing. Freezing risk is not only relevant in cold ambient conditions. The evaporator in the refrigeration circuits can get cold enough that there is freezing risk.

Glycol type: Use pure, lab-grade glycol. Haskris strongly recommends propylene glycol. Ethylene glycol is acceptable but not recommended because it is toxic.

Brands: DOWFROST is a common, high-quality product. Haskris also sells glycol. Contact Haskris for pricing if needed.

Water type: Use drinking/spring water. If a technical specification is needed, refer to ASTM D1193-91 Type IV water.

Mixture: Use a refractometer to verify glycol mix percentage of 35-40%.

Responsibility: The end-customer's or site's project team, contractors, or parties other than Haskris are responsible for providing the fluid, filling the system with the fluid, and providing additional spare glycol to top off the system.

Volume: Use the table below to estimate what volume of water and glycol fluid will be needed. Take the volume for the built-in reservoir and add the volume for the piping. Multiply the volume for the piping according to the length of piping. For example, if the piping length is 200 ft, multiply the volumes by 2.

	Water Volume	Glycol Volume
25 gal Built-in Reservoir	15 gallons 57 liters	10 gallons 38 liters
100 ft of 1-1/2" ID Pipe	9 gallons 34 liters	6 gallons 23 liters
100 ft of 2" ID Pipe	15 gallons 57 liters	10 gallons 38 liters

Fill the Reservoir

Purpose: The reservoir in the chiller is open to atmospheric pressure. Filling the reservoir separately from the piping will help ensure a smooth startup.

To fill the reservoir, follow procedure below.

1. Close supply and return ball valves.
2. Remove the cap from the top of the reservoir.
3. Fill the reservoir with glycol mixture.
4. Replace cap after filling.

Fill the Piping

Purpose: The piping must be full of fluid and all air must be removed from the piping. Filling the piping separately from the reservoir will help ensure a smooth startup.

To fill the piping, follow procedure below.

1. Verify supply and return ball valves are closed.
2. Remove cap from supply flush port and connect fill hose. Connect the other end of the hose to external fill pump.
3. Remove cap from return flush port and connect hose. Place the other end of hose in a bucket.
4. Open the supply and return side flush valves and energize external fill pump to fill piping with glycol mix.
5. When glycol mix begins to drain from return flush port, close the return side flush valve and replace cap.
6. Use air purge valves at high points in the piping to allow air to escape while fluid continues to fill the piping.
 - a. Open one purge point at a time.
 - b. When glycol mix comes out of the purge point, close air purge valves or isolation valve to seal the piping from atmospheric pressure.
7. After all purge points are sealed, close the supply side flush valve, deenergize external fill pump, and replace caps.
8. Open both supply and return ball valves.

Installation: Final Checks

Phase Monitor

Check: If the voltage and phase from the service disconnect is correct, the phase monitor should have a solid green LED or display ON.

If the phase monitor has a red LED or another visible fault, contact a licensed electrician to correct the fault.

Controller Faults

Check: Press the  button on the controller. The screen should say NO ALARMS. If any faults are described, consult Haskris to resolve these.

Pre-Startup Checklist

Directions: Email completed checklist to service@haskris.com at least 10 days in advance of start-up.

Model: _____ **Serial Number:** _____

Site Name: _____ **Address:** _____

Requested Start-up Date: _____

Location:

- Unit is securely mounted and level.
- Minimum of 72" clearance exists on condenser sides of the unit, minimum of 36" clearance exists on non-condenser sides of the unit, and space above unit is unobstructed.

Fluid Connections:

- All piping is of non-ferrous materials and complies with local codes.
- All piping is sealed and not open to atmospheric pressure.
- All fluid connections are insulated.
- Isolation/purge ball valves are installed on supply and return connections.
- Beginning and end of hard pipe runs are terminated with vibration isolators.
- Purge valves or hose bibs are installed at high points for purging air from the lines.
- Drain valves are installed at the base of every rise for emptying the lines.
- Heat traces are properly installed on all piping that will be exposed to temperatures below 20°F.

Electrical Power:

- Incoming voltage and circuit breaker size for incoming power match unit's nameplate.
- Confirm proper electrical power and phase by checking the phase monitor's status indicator.
- Incoming power will be uninterrupted so that compressor crankcase heater(s) will be energized for a minimum of 12 hours immediately prior to start-up.

Nominal Power: CHECK NAMEPLATE			
Record Voltage at Disconnect (V)	L1-L2		Confirm and Record Size of Time Delay Breaker (Fusing) Supplying OPC (A)
	L2-L3		
	L1-L3		

Communication Wiring:

- Unit is wired to remote control panel, and the remote control panel displays a mirror of the unit's controller display.
- Unit is wired to the WW indoor heat exchanger (if a WW was provided with this system).

Fluid fill:

- Piping has been flushed with external water until water runs clear.
- 100psi gas has been applied to piping loop for 30 minutes to check for leaks.
- Glycol concentrate, provided with the OPC, has been diluted with drinking/spring water to achieve a 35-40% glycol/drinking water solution.
- Tank and entire piping loop have been filled with 35-40% glycol/drinking water solution, and piping loop has been purged of air.
- Additional propylene glycol/drinking water solution is on-hand for service contractor to top off system when start-up is performed.
- Piping has been checked for fluid leaks.

Installation Completed By (Please Print):

Company: _____ Phone: _____ Email: _____

Name: _____ Title: _____

Signature: _____ Date: _____

Optional Modbus or BACnet Communication Capability

Building Management System

Purpose: Some facilities have centralized building monitoring systems (BMS). This requires a physical wire connection point between the chiller and the BMS. This also requires that the controller in the chiller be configured to communicate according to the configuration of the BMS.

Haskris Capability

- The standard Haskris chiller design is not capable of providing a connection point to the BMS.
- An additional controller must be added to the chiller to provide available connection points for the physical wire connection. This additional controller contains all necessary software licenses to communicate via BACnet.
- Haskris can provide this as an optional addition to the standard design.

Implementation

- If Haskris is notified within 2 week of shipment, Haskris can build the necessary modifications into the chiller at our factory.
- If this capability is needed after-the-fact in the field, contact Haskris for pricing and assistance with performing the necessary modifications.

Physical Connection

Controller: Chillers with BMS communication capabilities have 2 controllers.

- For OPC12 and OPC15, the controller for the BMS communication is in a separate smaller electrical enclosure, not the main electrical box. Wire connections need to be made with the controller in the smaller electrical enclosure.
- For OPC24, the controller for BMS communication is in the high voltage box, not the low voltage box. Wire connections need to be made with the controller in the high voltage box.

Wiring: There are 2 options, 3-wire RS-485 (MSTP) or ethernet TCP/IP. If 3-wire RS-485 is used, connect wires to TX-, RX+, and GND terminals on the J3 Disp. port (red below). If ethernet TCP/IP is used, connect an ethernet cable to the RJ45 port (blue below).

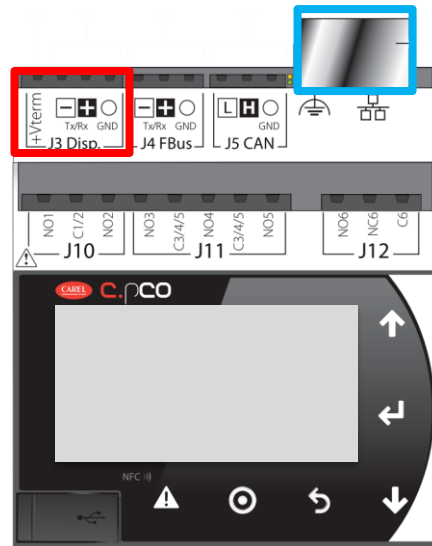























Connection Points for BMS

Settings Configuration

Purpose: The communication settings in the controller must be aligned with the details of the BMS at the site.

To configure the communication settings, follow procedure below.

1. Access the Service menu
2. Press the  or  buttons to highlight Communication
3. Press the  button

4. If the top of the screen does not say Communication, press the  or  buttons until it does
5. Press the  button to move the blinking cursor and select the appropriate communication option.
 - a. BACnetIP Ethernet
 - b. ModbusIP Ethernet
 - c. BACnet RS-485
 - d. Modbus RS-485
6. Press the  button to return the blinking cursor to the top left corner
7. Press the  or  buttons to access the associated settings based on the selected option
8. Press the  button to move the blinking cursor around the screen. Press the  or  buttons to adjust settings. There may be multiple pages of settings including the IP address if applicable.
 - a. To access the IP address settings, press the  and  buttons simultaneously for several seconds, the screen will change
 - b. First release the  button and second release the  button
 - c. Arrow down to SETTINGS, press the  button
 - d. Arrow down to TCP/IPv4 SETTINGS, press the  button
 - e. Press the  button to move the blinking cursor around the screen. Press the  or  buttons to adjust settings.
 - f. Press the  button to return the blinking cursor to the top left corner
9. After making all changes, power cycle the controller for the changes to take effect
10. Contact Haskris for support

Baud Rate Support

Note: When 3-wire RS-485 is used, baud rate is supported up to 57600.

A2L Refrigerant Supplemental Manual

Purpose: Some chiller designs include R454B refrigerant. R454B is an A2L category refrigerant. For these designs, a supplemental manual applies. The supplemental manual is available on the Haskris website via the following QR code and web link:



<https://haskris.com/live/wp-content/uploads/2025/01/MANUAL-PER-CSA-AND-UL-60335-2-89.pdf>

Startup

Phase Monitor

Purpose: A phase monitor is built into the chiller. This checks that incoming voltage, phase sequence, and other electrical characteristics are correct.

Types: There are 2 types of phase monitors used.

Type 1 Operation: The phase monitor is factory adjusted by Haskris according to the proper electrical settings for the chiller. Do not adjust the knobs on the phase monitor without discussion and approval from Haskris.

The phase monitor will show a solid green LED if the voltage and phase from the electrical service disconnect is correct. If the phase monitor has a solid or flashing red LED, contact a licensed electrician to correct the fault.

- Reversal is caused by the 3 lines being in an improper sequence.
 - To correct a reversal, switch any 2 of the 3 line connections.
 - Always make this switch in the wiring of the electrical service disconnect, not the chiller.
- Loss/unbalance is caused by a percentage difference in voltage between the 3 lines relative to each other.
- Undervoltage is caused by a percentage difference in voltage between the 3 lines compared to the line-line voltage knob setting.
- Overvoltage is caused by the voltage between the 3 lines being more than 10% over the line-line voltage knob setting.



	LED STATUS	STATUS
GREEN		NORMAL (RELAY ON)
		RESTART (DELAY)
RED		REVERSAL
		LOSS/UB (UNBALANCE)
		LOW VOLT (UNDERVOLTAGE)
		HIGH VOLT (OVERVOLTAGE)

Type 2 Operation: The phase monitor communicates many variables with the chiller's controller. Settings are configured by Haskris according to the proper electrical settings for the chiller. Do not adjust settings without discussion and approval from Haskris.

The phase monitor will show ON if the voltage and phase from the electrical service disconnect is correct. If the phase monitor displays a fault, contact a licensed electrician to correct the fault.

- "Bad Rotation" is caused by the 3 lines being in an improper sequence.
 - To correct a reversal, switch any 2 of the 3 line connections.
 - Always make this switch in the wiring of the electrical service disconnect, not the chiller.
- "Phase Loss" is caused by 1 phase being more than 30% below the line voltage selection
- "Imbalance" is caused by 1 phase being lower than the average voltage by more than a set percentage.
- "Voltage Low" is caused by the average voltage being less than a set undervoltage percentage.
- "Voltage High" is caused by the average voltage being more than a set overvoltage percentage.



ON/OFF Switch

Location: The chiller has a rotary ON/OFF switch located on the outside of the electrical box with the main controller.

Operation: Rotate the switch to make the chiller run when in the ON position (horizontal) or stop when in the OFF position (vertical). If a fault occurs, turning the switch to OFF and then back ON will reset the fault.



Auto Restart: If there is a power outage or an external interruption of power to the chiller, the chiller will stop immediately. As long as no components are damaged as a result of this event, when the power is restored, the chiller will automatically resume normal operation.

Pump Priming

Purpose: All fluid is removed from the pump head prior to shipment from Haskris. When starting the pump, it needs to be filled with fluid. This process is called priming the pump.

When the reservoir is full, the pump suction line is “flooded”. In some cases, this flooded suction will automatically prime the pump. When the chiller is turned ON, the pump will run. If the controller display shows the pump generating pressure, then the pump is primed.

If the controller display shows a low pressure <10 psi, then the pump did not automatically prime. Follow the procedure below.

1. Identify the priming plug on the face of the pump head



2. Use a 10mm hex or Allen wrench to loosen the priming plug slightly. The plug should remain threaded into the port, but air and liquid should be able to escape.
3. Allow air and a small amount of fluid to escape
4. Tighten the priming plug

Pump Supply Pressure

Purpose: The chiller uses a centrifugal pump. For the pump to run properly it needs some restriction in the piping system to push against the pump and generate pressure. If this does not happen the chiller may stop and show a fault.

Location: The chiller has a valve that can be used to adjust pump pressure. The valve type and location may vary depending on the model and when it was built.

- The valve may be inside the chiller on the return line
- The valve may be inside the chiller on the supply line
- The valve may be outside the chiller on the supply line

Operation: To increase the pressure, follow the procedure below.

1. Identify the adjustment valve. If the valve is a ball valve, the handle has been removed. It may be wrapped in insulation.
2. Start by closing this valve approximately halfway.
3. Cycle the ON/OFF switch on the chiller.
4. Observe the pump supply pressure on the controller display.
5. Close the valve to increase pump supply pressure.
6. Continue cycling the ON/OFF switch and adjusting the valve until you achieve a consistent, appropriate pressure.

Contact Haskris for help: Haskris is available to review pressure adjustments.

Pump Rotation Direction

Purpose: The pump motors must rotate the correct direction to provide proper pressure and flow. Haskris confirms proper rotation direction prior to shipment. The phase monitor is configured to be the primary check on rotation direction. Typically, no other verification is necessary for the pump rotation direction.

However, if there is any question about the rotation direction of the pumps there is an indicator on the motor.

Location: The indicator is attached to the endcap of the motor. The indicator is not permanently attached. If you do not see it, someone may have removed it intentionally or by accident.

Operation: Only check the indicator when the pump is running.

- If the indicator shows black, the rotation direction is correct.
- If the indicator shows white, the rotation direction is reversed.



Controller Display

Main Display

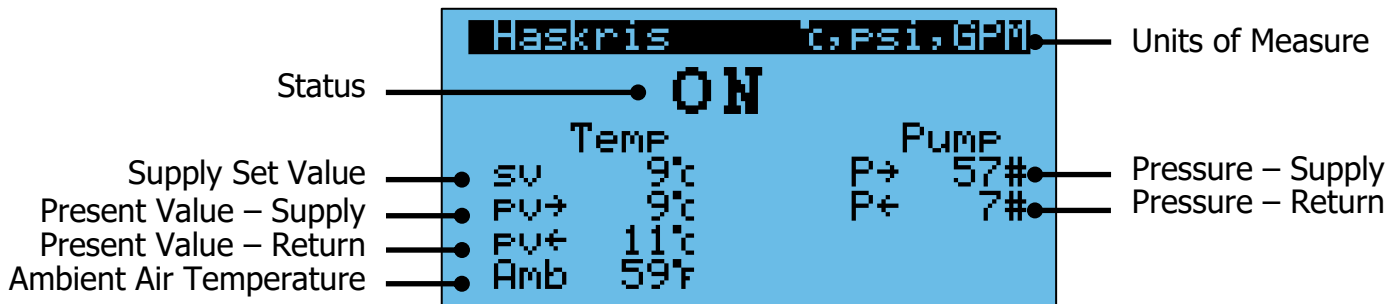

Operation: The main display shows the most important details about the chiller’s operation.

Status	The current state of the chiller
Supply Set Value	The desired temperature for the water/glycol mixture flowing to the MRI
Present Value – Supply/Return	Measured supply and return water/glycol temperatures
Pressure – Supply/Return	Measured supply and return water/glycol pressures
Ambient Air Temperature	Measured air temperature around the chiller





Status Modes: The status modes briefly describe if the chiller is operating normally or if there is something preventing it from normal operation.

ON-Startup	The ON/OFF switch is in the ON position, indicates the chiller is beginning operation. Appears while the chiller is initially working to control temperature.
ON-Running	The ON/OFF switch is in the ON position, indicates the normal running of the chiller once pv=sv is achieved
On-eco	The ON/OFF switch is in the ON position, indicates less cooling is required so fewer refrigeration circuits are running
OFF→Switch	The physical ON/OFF switch is in the OFF position
OFF→Alarm	An alarm or fault occurred and stopped the chiller
OFF→Keypad	A virtual ON/OFF switch on a controller screen is in the OFF position. This is only accessible in the service menu access.
OFF→BMS	The site’s BMS is connected to the chiller and sending it a signal to be OFF

Adjusting Set Value (sv)

Operation: Set Value is the only adjustable value on the main screen. Note that Haskris limits the range of adjustment. This is intended to prevent an improper adjustment that lead to inadequate cooling for the MRI.

To change the setting, follow the procedure below.

1. To change the value, press the  button to move the blinking cursor to the value
2. Press the  or  buttons to adjust the value
3. Press the  button to move the blinking cursor to the top left corner







Units of Measure

Purpose: Several combinations of units of measure are available depending on what is most useful.





The following units of measure are available:

- CAN (°C, psi, GPM)
- UK (°C, bar, IGM)
- USA (°F, psi, GPM)
- SI (°C, bar, LPM)

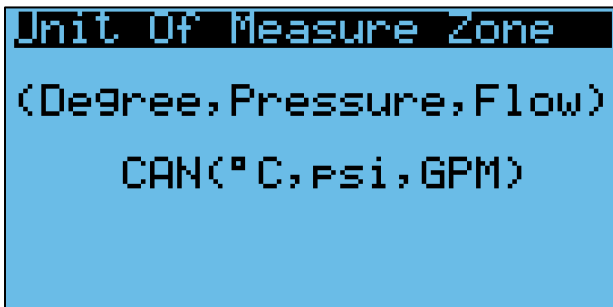
To change the units of measure, follow procedure below.

1. Begin on the main display
2. Press the  button on the controller
3. Press the  or  buttons to highlight Settings
4. Press the  button to go into that menu section
5. Press the  or  buttons until you see Unit of Measure Zone



6. Press the  button to move the blinking cursor around the screen
7. Press the  or  buttons to select different units of measure
8. Press the  button several times to return to the main display

Faults

Identify if there is a fault: The  button will flash red when there is a fault.

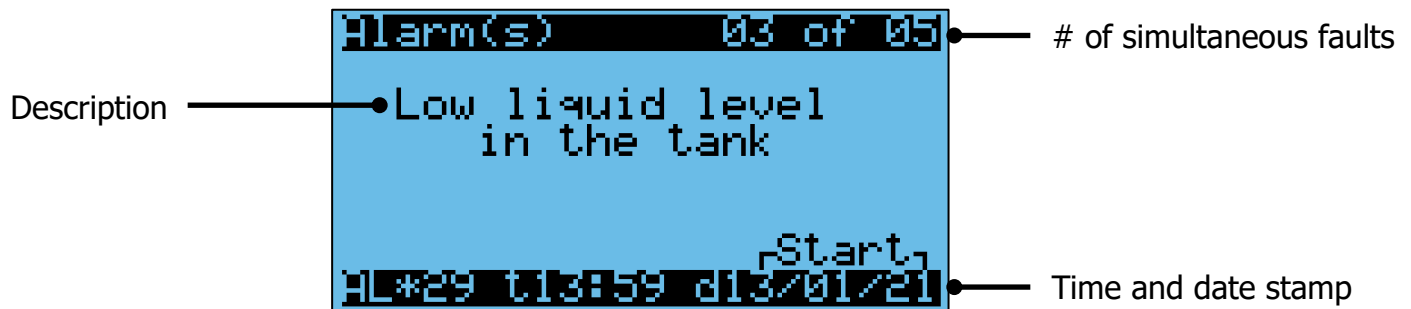

Display faults and details: Press the  button to see fault descriptions.

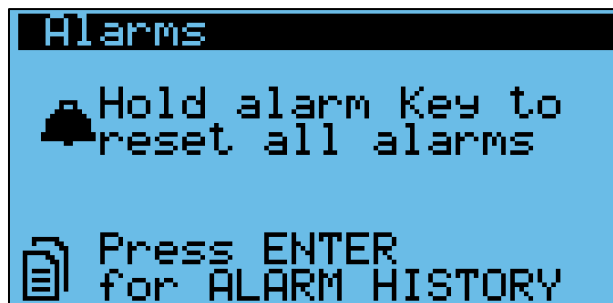

Description: Provides information about the specific fault.

Multiple faults: If only 1 fault is active, you will see 01 of 01. If multiple faults occur before the faults have been cleared, you will see ## of ## in the top right-hand corner. At the bottom you will see a time and date stamp HH:MM DD/MM/YY



Fault Reset: Press the  or  buttons until you go past the last active fault, you will see this screen which explains how to reset faults. Press and hold the  button for a few seconds to reset faults.

Fault history: When the screen says NO ALARMS, there are no faults currently. Press the  button to see the fault history if needed.

Start and stop: In the bottom right-hand corner, certain faults will display "Start" or "Stop". Start indicates when the fault occurred. Stop indicates when the fault was cleared.

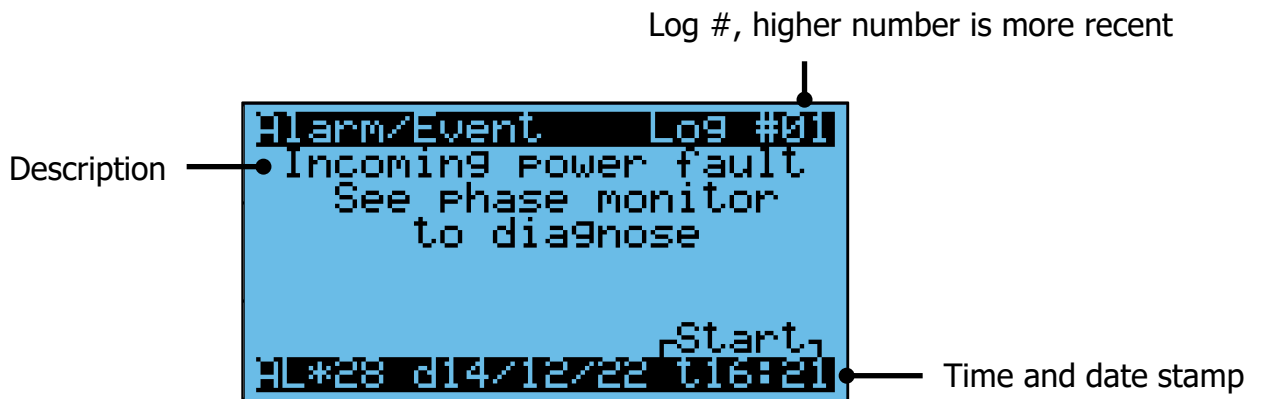

Common Faults









Wording	Explanation	Notes to Resolve
Incoming power fault	Phase monitor detected improper power	Check the phase monitor in the high voltage electrical box, see the LED status light and fault codes
Liquid level warning	Liquid level below upper threshold	This is a warning, check for a leak and add fluid so the level is at the fill line
Low liquid level	Liquid level below lower threshold	Check for a leak and add fluid so the level is at the fill line
Pump low pressure	Pressure sensor reading low on pumping circuit	Confirm pump is primed and check ball valve adjustment
Pump high pressure	Pressure sensor reading high on pumping circuit	Inspect external piping for a restriction to flow. All external shut off valves should be fully open. All filters and strainers should be clean.
High fluid return pressure	Pressure sensor reading high on return line	Check the internal wye strainer on the return of the chiller, clean the strainer screen
Pump high amp draw	Pump overload contact opened	Reset alarm, check overload, measure pump amp draw
High refrig press	Pressure sensor reading high on a refrigeration circuit	Confirm the fan is spinning and check the condenser for debris or blockage that could reduce air flow
High refrig safety switch open	Pressure safety switch on a refrigeration circuit opened	
Low refrig press	Pressure sensor reading low on a refrigeration circuit	Contact Haskris for diagnostics and troubleshooting

Access Service Menu

Purpose: A separate Service menu is locked behind a password. This gives access to hidden displays and some override controls. Entering the password enables advanced options to interact with the chiller.

To access the Service menu, follow the procedure below.

Password: 6420

1. Begin on the main display
2. Press the  button on the controller
3. Press the  or  buttons to highlight Service. Press the  button 2 times.
4. Press the  or  buttons to change 1 digit at a time
5. Press the  button to move the blinking cursor
6. Press the  button to enter the password
7. You will see the Service menu









8. Press the  button several times to return to the main display

Logout of Service Menu

Notes: When you have completed using the advanced capabilities of the Service menu it is important to logout.

To logout of the service menu, follow the procedures below.

1. Begin on the main display
2. Press the  button on the controller
3. Press the  or  buttons to highlight Service. Press the  button.
4. Press the  or  buttons to highlight Logout. Press the  button 2 times.

Capabilities in the Service Menu

Purpose: There are additional main displays that give the following abilities:

- Observe detailed refrigeration data
- Override refrigeration circuits ON or OFF

Observe Detailed Refrigeration Data or Force a Specific Circuit to Run

Purpose: The chiller has sensors to monitor the following refrigeration conditions for each refrigeration circuit using the screen below.

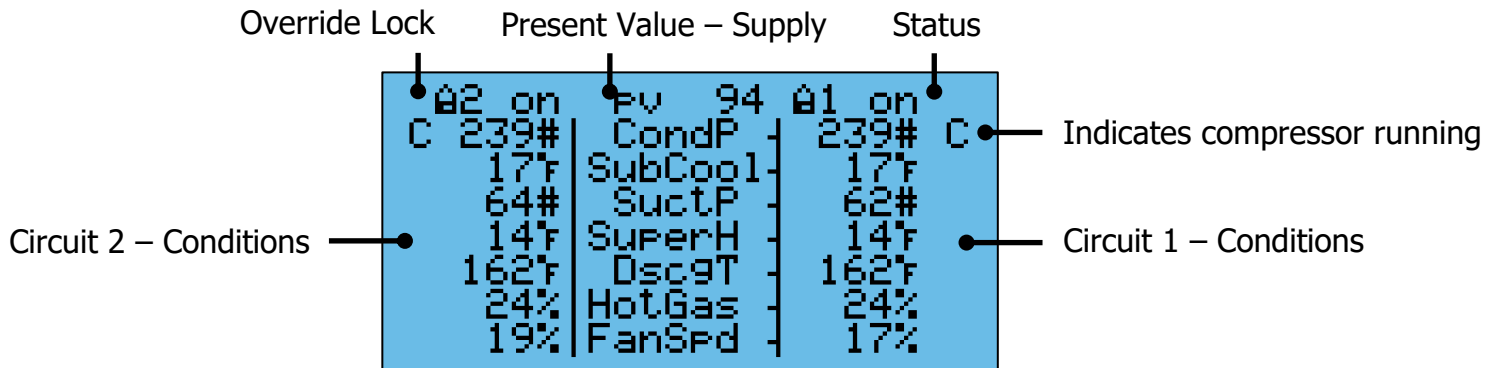









Operation: The detailed refrigeration display shows more about the chiller's operation.

- CondP: Refrigerant head pressure in the condenser.
- SubCool: Refrigerant subcooling in the liquid line
- SuctP: Refrigerant pressure in the evaporator
- SuperH: Refrigerant superheat in the compressor suction line
- DscgT: Refrigerant temperature in the compressor discharge line
- HotGas: The % to which the hot gas bypass valve is open
- FanSpd: The % to which the EC fans are at their max speed

It may be necessary for preventative maintenance or service to force a specific refrigeration circuit ON or OFF.

To force a specific refrigeration circuit to run, follow the procedure below.





1. Access the Service menu
2. Press the  button until you see the main display
3. Press the  button to move the blinking cursor to the  symbol of the circuit you want to override
4. Press the  button to unlock this symbol, it should look like this 
5. Press the  button to move the blinking cursor to the ON/OFF status of that circuit
6. Press the  or  buttons to force that circuit to be ON or OFF

Both Overrides Locked

Circuit 1 Override Unlocked
Override ON

■ 02off	EV 10°C	01off
171#	CondP	173#
0%	SubCool	0%
132#	SuctP	131#
2%	SuperH	2%
78%	Dsc9T	78%
35%	HotGas	35%
0%	FanSpd	0%

02off	EV 11°C	01 ON
165#	CondP	170#
0%	SubCool	0%
138#	SuctP	135#
3%	SuperH	3%
81%	Dsc9T	81%
35%	HotGas	35%
0%	FanSpd	0%

7. To stop the override, press the  button to move the blinking cursor to the 
8. Press the  button to lock this symbol, it should look like this 
9. Logout of the Service menu when finished

Chiller Features

Cellular Communication and Remote Monitoring

Purpose: The chiller uses a cellular connection to enable Haskris to remotely view the controller 24/7/365 for diagnostics and addressing issues. Haskris can receive alerts if there are faults.

Method: The chiller has a cellular modem and 2 antennas to communicate with the cell towers.

Active duration: This is active by default during the 1st year while the chiller is under warranty. When the chiller is covered by a service contract with Haskris, this remote monitoring capability is extended.

Local Monitoring and Remote Control Panel

Purpose: The chiller can be monitored locally by users or facilities personnel as needed.

Method: The chiller includes a remote control panel which can be installed indoors in the MRI equipment room. This provides a convenient way to interact with the chiller indoors.

Operation: This is an identical mirror of the controller in the outdoor chiller. Any changes done on the remote control panel are immediately reflected on the chiller. For example, if someone changes the set point on the remote control panel, the chiller will reflect this change.

Other method: The chiller also has available potential free fault contacts on the controller.

Operation: The potential free contact is the J12 terminal on the controller. There is a NO and NC contact available as needed.

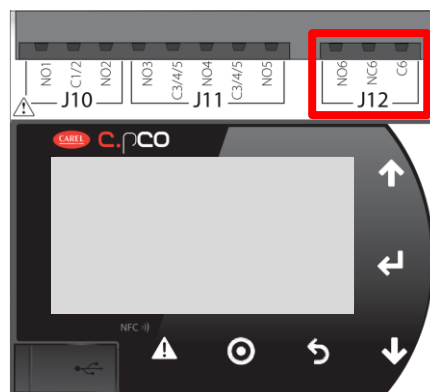

Separate Independent Refrigeration Circuits

This section applies to OPC24 only

Purpose: The chiller has identical, parallel refrigeration circuits to enhance uptime.

Notes: If one of the refrigeration circuits has a fault, the other(s) can continue running. All circuits have adequate capacity to keep the magnet cold on their own, so the magnet can continue to have proper cooling while service or repairs are being performed.

E-coated Condensers for Corrosion Resistance

Purpose: The condensers that are installed on this chiller have an e-coating. This coating protects the condenser from corrosion. This is particularly important in coastal areas with salty ocean air.

Energy Saving eco Mode

This section applies to OPC24 only

Purpose: When the chiller is under a reduced load, the chiller will use fewer refrigeration circuits to provide cooling to reduce power consumption.

Operation: When the chiller is in eco mode, the status on the display will say "ON eco". The controller initiates eco mode based on the operation of the refrigeration hot gas bypass valves and the refrigerant head pressure.

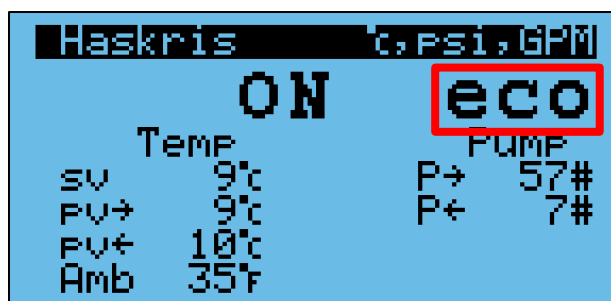

Dynamic Capacity Control

Purpose: The chiller can operate normally and control temperature across the full range of heat loads from no load to full load.

Operation: During startup, the chiller can run under no load for extended periods of time if needed. This will not reduce the long-term performance or reliability of the chiller. During normal operation, the chiller responds to changes in heat load from moment to moment and supply stable supply fluid temperature to the MRI.

Maintenance

Frequency

Schedule: Inspections should happen at least once every 12 months. If the chiller is not being monitored remotely by Haskris, inspection every 6 months is recommended.

Activity: During each inspection, preventative maintenance should be performed. Use the Haskris provided Preventative Maintenance checklist.

Glycol Mixture

Purpose: The chiller is designed to circulate a mixture of drinking/spring water and pure glycol. This glycol is intended to help resist water freezing.

Maintenance: The full level in the reservoir is marked on the side of the reservoir. If the level falls, replenish the reservoir as needed until the reservoir remains full. Use a refractometer to verify glycol mix percentage of 35-40%. If the glycol mix is visibly dirty or contaminated flush the glycol from the whole system and refill with a fresh glycol mix.

Wye Strainer

Purpose: A wye strainer is installed inside or outside the chiller on the return line to catch particles in the fluid.

Maintenance: If the return pressure is above 15 psi, clean the wye strainer.

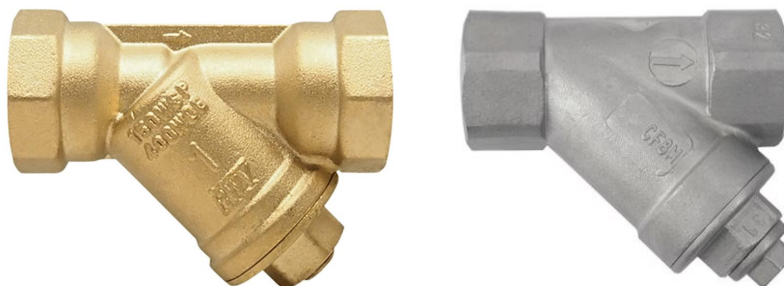

Condenser Coils

Maintenance: Dust and debris may collect on the condenser during normal operation. Accumulated debris restricts air flow and reduces heat transfer which affects chiller performance. Use a brush to loosen compacted debris and use a vacuum to collect the debris.

Electrical Inspection

Maintenance: Use a multimeter to check electrical values. Take measurements at contactors or terminal blocks. Compare values to the chiller or component name plate. Chillers include a phase monitor. Refer to the fault indicators provided on the phase monitor and contact a licensed electrician to correct any faults.