



WATER CHILLERS

776 North Oaklawn Avenue
Elmhurst, Illinois 60126 USA

PH: +1-847-956-6420

EMAIL: sales@haskris.com

HASKRIS.COM

WW-SERIES MANUAL

Table of Contents

HASKRIS CONTACT INFORMATION	3
TECHNICAL REQUIREMENTS	4
CLEARANCES	4
LOCATION.....	4
FACILITY WATER.....	4
INSTALLATION	5
LINE SIZING.....	5
PIPING	7
ELECTRICAL	8
FILLING THE RESERVOIR.....	9
STARTUP	10
ON/OFF SWITCH	10
PUMP PRIMING.....	11
BYPASS PRESSURE RELIEF VALVE	12
PUMP SUPPLY PRESSURE	13
FINAL CHECKS.....	13
CONTROLLER DISPLAY	14
MAIN DISPLAY.....	14
STATUS MODES.....	14
ADJUSTING SET VALUE (SV)	15
UNITS OF MEASURE	16
FAULTS	17
REMOTE COMMUNICATION CAPABILITY	19
REMOTE COMMUNICATION OPTIONS	19
MODBUS AND BACNET	20
BAUD RATE SUPPORT	21
MAINTENANCE	22
SUCTION STRAINER	22
PARTICLE FILTER	22
WYE STRAINER	22
LIQUID LEVEL AND WATER QUALITY.....	23

Haskris Contact Information

Contact Haskris with any questions about a unit and/or the information in this manual. Haskris has a team of engineers available to answer questions, troubleshoot issues, or provide supplemental information as needed. Please have the serial number of the Haskris unit available for reference.

Phone: 001 847 956 6420

Email: service@haskris.com or sales@haskris.com

Technical Requirements

Note: Features and customizations may impact the technical requirements. Contact Haskris for details about a specific unit or design.

Clearances

- Maintain at least 6 inches (15 cm) clearance on the sides and rear.
- Maintain at least 36 inches (91 cm) on the front for access to the main controller during normal operation.
- Maintain access to the top of the unit.
- Additional clearances on the sides and rear may be required for service.

Location

- Locate the unit in a clean indoor environment.

Facility Water

- Units are built to order based on the application cooling requirements and site conditions. The facility water requirements vary. Refer to the quote document or other technical document specific to the unit for facility water requirements, or contact Haskris with any questions.

Installation

Line Sizing

Contact Haskris for help: Haskris is available to review pipe runs, pressure drop, etc. and make recommendations for individual sites.

Approach to line sizing

- Size all interconnecting hose and piping equal to or larger than the connections on the unit.
- Pressure drop in the external piping is a function of fluid flow rate, pipe inner diameter, pipe length, the number and type of fittings, and other factors.
- Generally, external piping should be sized to minimize pressure drop. Approximately 5 psi (0.34 bar) or less is a good goal.

For applications requiring approximately 8 LPM (2.1 GPM) or less

- If the total straight pipe length is less than 90 ft (27.4 m) use 1/2" nominal pipe size (ID).
- If the total straight pipe length is less than 250 ft (76.2 m) use 5/8" nominal pipe size (ID).
- If the total straight pipe length is less than 475 ft (144.8 m) use 3/4" nominal pipe size (ID).

For applications requiring approximately 16 LPM (4.2 GPM) or less

- If the total straight pipe length is less than 25 ft (7.6 m) use 1/2" nominal pipe size (ID).
- If the total straight pipe length is less than 75 ft (22.9 m) use 5/8" nominal pipe size (ID).
- If the total straight pipe length is less than 140 ft (42.7 m) use 3/4" nominal pipe size (ID).
- If the total straight pipe length is less than 550 ft (167.6 m) use 1" nominal pipe size (ID).

For applications requiring approximately 24 LPM (6.3 GPM) or less

- If the total straight pipe length is less than 40 ft (7.6 m) use 5/8" nominal pipe size (ID).
- If the total straight pipe length is less than 75 ft (22.9 m) use 3/4" nominal pipe size (ID).
- If the total straight pipe length is less than 300 ft (91.4 m) use 1" nominal pipe size (ID).

For applications requiring approximately 39 LPM (10.3 GPM) or less

- If the total straight pipe length is less than 29 ft (8.8 m) use 3/4" nominal pipe size (ID).
- If the total straight pipe length is less than 115 ft (35.1 m) use 1" nominal pipe size (ID).
- If the total straight pipe length is less than 340 ft (103.6 m) use 1-1/4" nominal pipe size (ID).

For applications requiring approximately 55 LPM (15.1 GPM) or less

- If the total straight pipe length is less than 63 ft (19.2 m) use 1" nominal pipe size (ID).
- If the total straight pipe length is less than 185 ft (56.4 m) use 1-1/4" nominal pipe size (ID).
- If the total straight pipe length is less than 480 ft (146.3 m) use 1-1/2" nominal pipe size (ID).

For applications requiring approximately 76 LPM (20.1 GPM) or less

- If the total straight pipe length is less than 105 ft (32.0 m) use 1-1/4" nominal pipe size (ID).
- If the total straight pipe length is less than 270 ft (82.3 m) use 1-1/2" nominal pipe size (ID).

For applications requiring approximately 95 LPM (25.1 GPM) or less

- If the total straight pipe length is less than 70 ft (21.3 m) use 1-1/4" nominal pipe size (ID).
- If the total straight pipe length is less than 185 ft (56.4 m) use 1-1/2" nominal pipe size (ID).
- If the total straight pipe length is less than 700 ft (213.4 m) use 2" nominal pipe size (ID).

For applications requiring approximately 133 LPM (35.1 GPM) or less

- If the total straight pipe length is less than 100 ft (30.5 m) use 1-1/2" nominal pipe size (ID).
- If the total straight pipe length is less than 390 ft (118.9 m) use 2" nominal pipe size (ID).

For applications requiring approximately 190 LPM (50.2 GPM) or less

- If the total straight pipe length is less than 200 ft (61.0 m) use 2" nominal pipe size (ID).
- If the total straight pipe length is less than 510 ft (155.4 m) use 2-1/2" nominal pipe size (ID).

Piping

- Comply with local codes for proper piping.
- For short runs, use opaque 150 psi minimum rated reinforced EPDM hose. Do not use clear braided hose.
- For long runs, use copper piping. Terminate the beginning and end of hard runs with vibration isolators or a short segment of hose to absorb vibration. It is recommended to flush long runs of piping.
- For hard runs that have piping rises, install manual ball valves at high points in the piping to facilitate purging air while filling the lines.
 - Automatic purge valves may be used, but isolation ball valves must be installed before the purge valves.
 - Purge valves must be closed during normal operation. This ensures the piping can be fully sealed from atmospheric pressure.
- Insulate piping to minimize condensation.
- Label supply and return lines over insulation with arrows indicating flow directions.
- Install isolation ball valves on the supply and return connections at the unit.
- Install isolation ball valves on the facility water inlet and outlet connections at the chiller.
- It is recommended to install an 80-mesh wye strainer at the building water inlet. This will provide some protection for the heat exchanger if the facility water has particulate contaminants.

Electrical

- Comply with proper local electrical codes.
- Contact a licensed electrician to perform the electrical installation.
- The electrician should verify that the wiring is adequate in the installation area.
- Refer to the nameplate label on the rear of the unit for detailed electrical requirements.

Power cord: Some units include a power cord. Hardwire the power cord to an electrical service disconnect or add the appropriate plug per local codes and site requirements.

For units without a power cord, connect incoming power to the labeled terminal block inside the unit's electrical enclosure.

Service disconnect: Use a dedicated service disconnect and time-delay fusing or circuit breaker per the electrical requirements on the unit's nameplate label.

Phase monitor: Units configured for 3-phase electrical include a phase monitor. Refer to the fault indicators provided on the phase monitor and contact a licensed electrician to correct any faults.



Phase monitor

	LED STATUS	STATUS
GREEN		NORMAL (RELAY ON)
		RESTART (DELAY)
RED		REVERSAL
		LOSS/UB (UNBALANCE)
		LOW VOLT (UNDERVOLTAGE)
		HIGH VOLT (OVERVOLTAGE)

Phase fault LED status patterns

Filling the Reservoir

- Remove the lid from the top of the reservoir.
- Remove any packaging material from inside the tank.
- Fill the reservoir with clean, potable (drinkable) distilled water.
- For reservoirs that have a fill line, stop filling when the water is at the fill line. For reservoirs that do not have a fill line but do have a threaded fill cap, stop filling when the water level is just below the threaded neck at the top. For reservoirs that do not have a fill line or a threaded fill cap, stop filling when the water level is just below the black fittings on the tank wall.
- Make sure additional water is on hand when the unit is started up to top off the liquid level as the external piping is filled.
- Note: Some units are designed for compatibility with other fluids. Contact Haskris if you are unsure what fluids are compatible with your unit.

Startup

ON/OFF Switch

Location: The unit has a rocker ON/OFF switch or a rotary ON/OFF switch located on the front of the unit.

Operation: Toggle the switch to the ON position to make the unit run. Toggle the switch to the OFF position to make the unit stop. If a fault occurs, toggling the switch to OFF and then back ON will reset the fault.



ON/OFF switch examples

Pump Priming

Purpose: All fluid is removed from the pump head prior to shipment from Haskris. When starting the pump, it needs to be filled with fluid. This process is called priming the pump.

When the reservoir is full, the pump suction line is “flooded”. In most cases, this flooded suction will automatically prime the pump. When the unit is turned ON, the pump will run. If the controller display or pressure gauge shows the pump generating pressure, then the pump is primed.

If the controller display or pressure gauge shows a low pressure <10 psi, then the pump did not automatically prime. Follow the procedure below.

1. Identify the priming plug on the face of the pump head

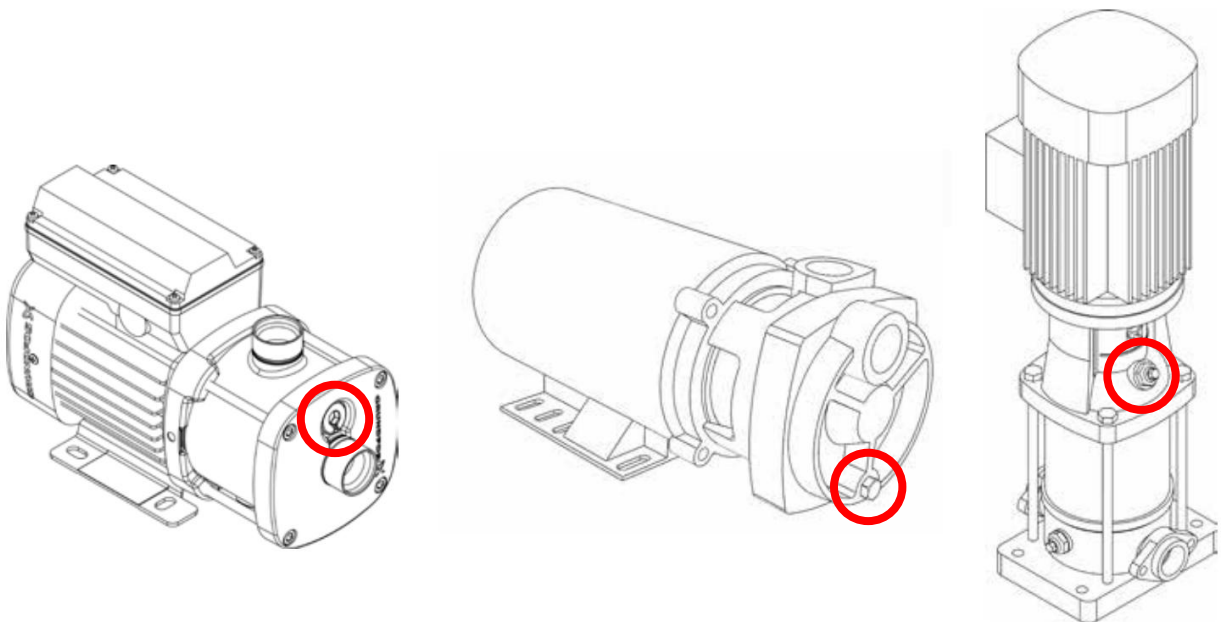

Pump priming plug circled

2. Use an adjustable or hex or Allen wrench to loosen the priming plug slightly. The plug should remain threaded into the port, but air and liquid should be able to escape.
3. Allow air and a small amount of fluid to escape
4. Tighten the priming plug

Bypass Pressure Relief Valve

Purpose: Some unit designs use a turbine pump. These designs also include a bypass pressure relief valve. The valve limits pressure by opening to bypass flow internal to the unit.

The procedure below can be used to adjust the bypass pressure relief valve setting.

1. Identify the bypass relief valve installed at the pump discharge. An example picture is below.
2. Unthread the knurled cylindrical cap to reveal the threaded adjustment post beneath it.
3. Use a wrench to loosen the nut at the base of the adjustment post.
4. Completely restrict the external cooling circuit, for example by closing a ball valve at the unit's supply connection or kinking a hose. Look at the pressure reading on the controller or gauge.
 - The pressure that results is the bypass relief valve setting
 - This is the highest pressure the external system will experience if a restriction developed in the cooling circuit
5. On the bypass relief valve, use a flat head screwdriver to rotate the adjustment post.
 - Rotate clockwise to increase pressure
 - Rotate counterclockwise to decrease pressure
6. After a small adjustment, remove the restriction from step 4 to see how much flow and pressure results to the application.
7. If more adjustment is required, repeat steps 4 through 6 until the required flow/pressure is available to the application.
8. Use a wrench to tighten the nut at the base of the adjustment post and reinstall the knurled cap.



Bypass pressure relief valve, with adjustment post uncovered

Pump Supply Pressure

Purpose: Some chiller designs use a centrifugal pump. For a centrifugal pump to run properly it needs some restriction in the piping system to push against the pump and generate pressure. If this does not happen the chiller may stop and show a Pump Low Pressure fault.

To correct this, follow the procedure below.

1. Slightly close a ball valve or other type of metering valve on the external piping circuit
2. Cycle the ON/OFF switch on the chiller
3. Observe the pump supply pressure on the controller display, it should be higher than before
4. If the chiller faults again on Pump Low Pressure, repeat steps 1-3 until the Pump Low Pressure fault no longer occurs

Note: When partially closing a ball valve from a fully open position, it is normal to see no change in operating pressure until the handle is adjusted a significant amount.

Contact Haskris for help: Haskris is available to review pressure adjustments.

Final Checks

- Verify that flow and pressure through the system piping meet the application requirements. Adjust bypass relief valve or modulate a valve in the external circuit as needed to achieve the required flow and pressure.
- As piping fills with fluid, the level in the tank will drop. Have water available to replenish the tank level as necessary. If the water level in the tank drops below the liquid level switch, the unit may shut down.
- Check to make sure all external piping is leak-tight and that the system is operating satisfactorily.
- If debris from the lines is deposited into the tank, drain the tank and refill with clean water.
- Allow a minimum of 15 minutes for temperature to stabilize following adjustments.

Controller Display

Main Display

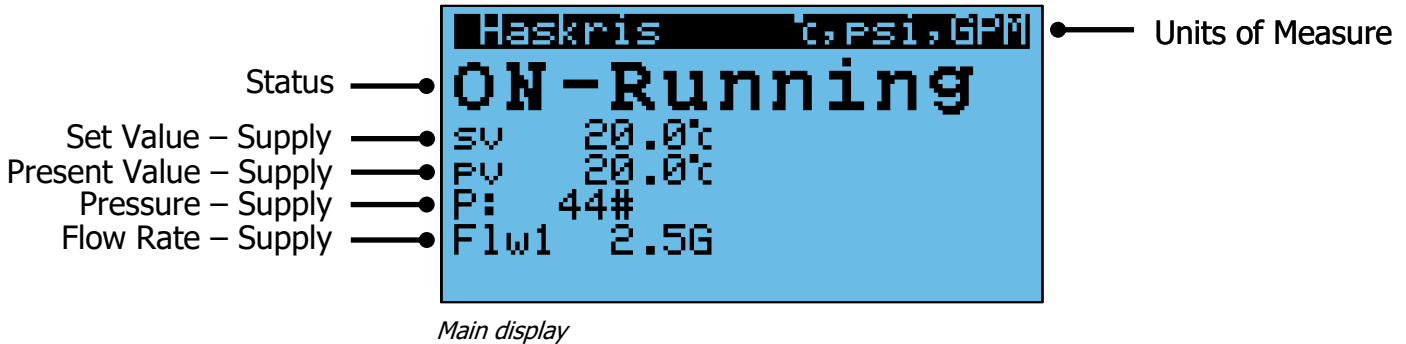

Status	Indicates the state of the unit
Set Value - Supply	The desired supply fluid temperature
Present Value - Supply	Measured supply fluid temperature
Pressure - Supply	Measured supply pressure
Flow Rate - Supply	Measured supply flow rate (if applicable)

Description of main display data

Status Modes





ON - Startup	The ON/OFF switch is in the ON position Indicates the unit is beginning operation. Appears while the unit is initially working to control temperature.
ON - Running	The ON/OFF switch is in the ON position Indicates the normal running of the unit once sv is achieved
OFF --> Switch	The physical ON/OFF switch is in the OFF position
OFF --> Alarm	An alarm or fault occurred and stopped the unit
OFF --> Remote	The Remote ON/OFF feature is enabled, and the remote signal is either not present or is telling the unit to be OFF

Description of status modes

Adjusting Set Value (sv)

Notes: Set Value is the only adjustable value on this screen.

To change the setting, follow the procedure below.

1. To change the value, press the  button to move the blinking cursor to the value
2. Press the  or  buttons to adjust the value
3. Press the  button to move the blinking cursor to the top left corner







Units of Measure

Purpose: Several combinations of units of measure are available depending on what is most useful.

The following units of measure are available:



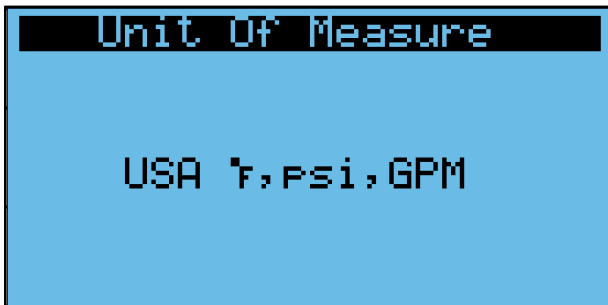

- CAN (°C, psi, GPM)
- UK (°C, bar, IGM)
- USA (°F, psi, GPM)
- SI (°C, bar, LPM)

To change the units of measure, follow procedure below.

1. Begin on the main display
2. Press the  button on the controller
3. Press the  or  buttons to highlight Settings
4. Press the  button to go into that menu section
5. Press the  or  buttons until you see Unit of Measure Zone



Units of measure screen

6. Press the  button to move the blinking cursor around the screen
7. Press the  or  buttons to select different units of measure
8. Press the  button several times to return to the main display

Faults

Identify if there is a fault: The  button will flash red when there is a fault.

Display faults and details: Press the  button to see fault descriptions.

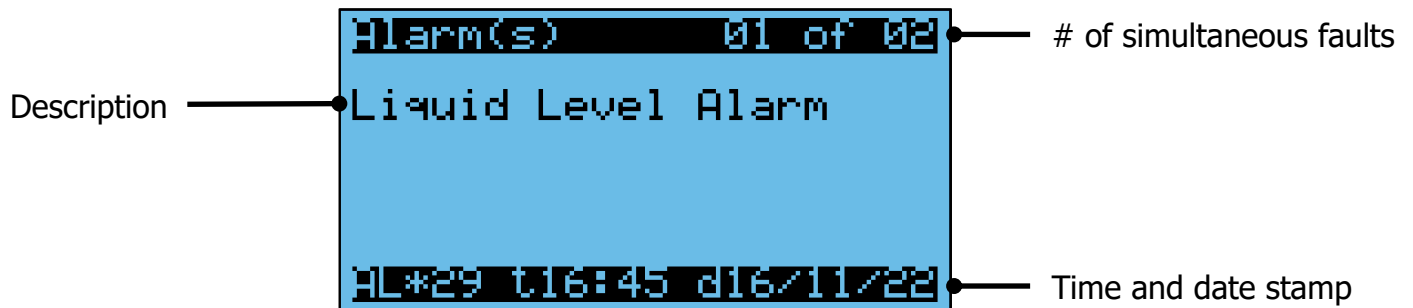

Example fault screen

Description: Provides information about the specific fault.

Multiple faults: If only 1 fault is active, you will see 01 of 01. If multiple faults occur before the faults have been cleared, you will see ## of ## in the top right-hand corner. At the bottom you will see a time and date stamp HH:MM DD/MM/YY

Fault reset: Press the  button until you go past the last active fault, you will see this screen which explains how to reset faults.

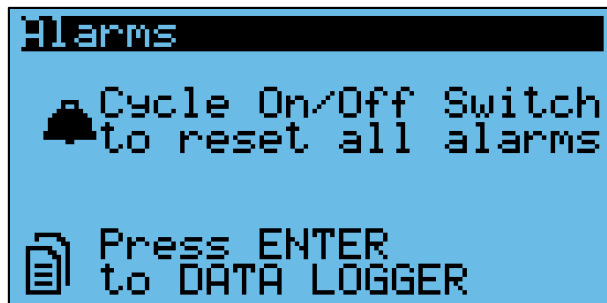

Fault reset screen

Fault history: When the screen says NO ALARMS, there are no faults currently. Press the  button to see the fault history if needed.

Start and stop: In the bottom right-hand corner, certain faults will display "Start" or "Stop". Start indicates when the fault occurred. Stop indicates when the fault was cleared.

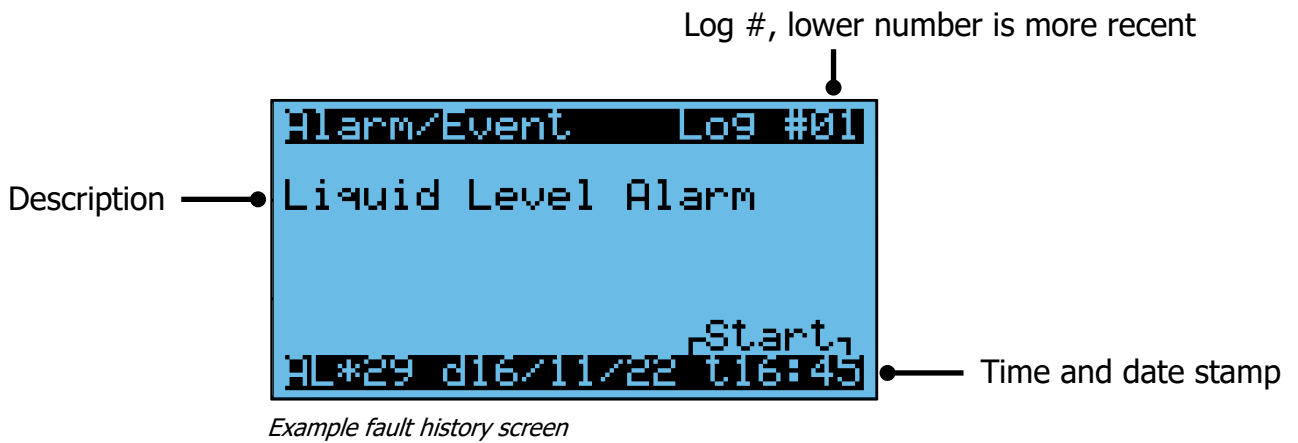

Common Faults		
Wording	Explanation	Notes to Resolve
High Temp Alarm	Supply fluid temperature reading high	Confirm facility water flow and pressure is available
Liquid Level Alarm	Liquid level below liquid level switch	Check for a leak and add fluid so the level is near the full level
Phase Alarm	Phase monitor detected improper power	Check the phase monitor in the electrical enclosure, see the LED status light and error codes
Pump Overload Alarm	Pump overload contact opened	Reset alarm, check overload and push reset button if necessary, measure pump amp draw

Description of common faults

Remote Communication Capability

Remote Communication Options

Purpose: Units can be configured by Haskris with several remote communication capabilities.

Examples include:

- Alarm contacts
- Remote ON/OFF interlock
- Modbus capability
- BACnet capability

Contact Haskris for help: Haskris is available to provide detailed information about a specific design's capabilities.

Modbus and BACnet

Purpose: Some facilities have centralized building monitoring systems (BMS). This requires a physical wire connection point between the unit and the BMS as well as appropriate software in the unit. Some units with PLC control are equipped with the capability to communicate with a BMS.



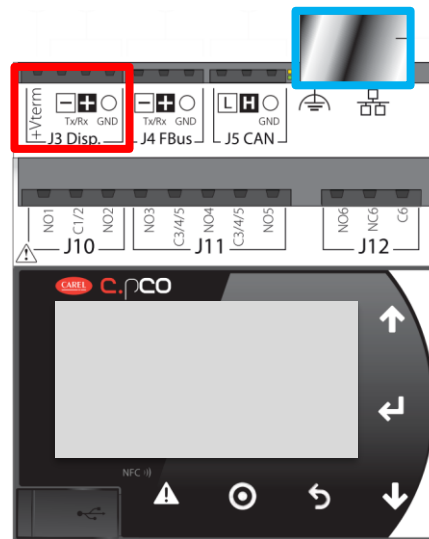



Wiring: There are 2 options, 3-wire RS-485 (MSTP) or ethernet TCP/IP. If 3-wire RS-485 is used, connect wires to TX-, RX+, and GND terminals on the J3 Disp. port. A dedicated terminal strip may also be provided for these connections. If ethernet TCP/IP is used, connect an ethernet cable to the RJ45 port. Refer to figure on the next page.



























Connection Points for BMS

Settings Configurations: The communication settings in the controller must be aligned with the details of the BMS at the site.

To configure the communication settings, follow the procedure below.

1. Press the  button on the controller
2. Press the  or  buttons to highlight Service. Press the  button 2 times.
3. Enter the password as 6420
 - a. Press the  or  buttons to change 1 digit at a time
 - b. Press the  button to move the blinking cursor

4. Press the  button to enter the password
5. Press the  or  buttons to highlight Communication
6. Press the  button
7. If the top of the screen does not say Communication, press the  or  buttons until it does
8. Press the  button to move the blinking cursor and select the appropriate communication option
 - a. BACnetIP Ethernet
 - b. ModbusIP Ethernet
 - c. BACnet RS-485
 - d. Modbus RS-485
9. Press the  button to return the blinking cursor to the top left corner
10. Press the  or  buttons to access the associated settings based on the selected option
11. Press the  button to move the blinking cursor around the screen. Press the  or  buttons to adjust settings. There may be multiple pages of settings including the IP address if applicable
 - a. To access the IP address settings, press the  and  buttons simultaneously for several seconds, the screen will change
 - b. First release the  button and second release the  button
 - c. Press the  to highlight SETTINGS, press the  button
 - d. Press the  to highlight TCP/IPv4 SETTINGS, press the  button
 - e. Press the  button to move the blinking cursor around the screen. Press the  or  buttons to adjust settings.
 - f. Press the  button to return the blinking cursor to the top left corner
12. After making all changes, power cycle the controller for the changes to take effect
13. Contact Haskris for support

Baud Rate Support

Note: When 3-wire RS-485 is used, baud rate is supported up to 57600.

Maintenance

Schedule: Inspection interval depends on environmental and operating conditions. At least every 6 to 12 months is recommended.

Suction Strainer

Purpose: Some units have a nylon suction strainer in the tank to prevent debris from entering the pump suction.

Maintenance: Check the strainer for debris or biological growth. If debris is present the strainer can sometimes be cleaned, but if debris is significant or built up inside the strainer then it may need to be replaced. Replacement strainers are available from Haskris.

Notes: A dirty strainer can cause cavitation which can damage the pump. Failure due to cavitation is not covered under the warranty.

Particle Filter

Purpose: Some units include a particle filter which captures debris leaving the unit. The filter housing is mounted on the back of the unit or inside the unit.

Maintenance: Record the pump's running fluid pressure at the completion of startup when the filter is clean. Replace the filter when the pressure increases 5psi to 6 psi (0.3bar to 0.4 bar) above the startup running pressure. Replacement filters are available from Haskris.

Wye Strainer

Purpose: The installation may include a wye strainer which captures debris from the building water.

Maintenance: Clean the wye strainer during routine maintenance. If there is a pressure gauge between the facility water inlet and the wye strainer, then clean the wye strainer every time the pressure at the wye strainer inlet has increased 10 psi (0.7 bar) or more.

Liquid Level and Water Quality

Purpose: Maintaining sufficient volume of clean water ensures proper operation of the unit and consistent cooling flow.

Maintenance: Check the water in the reservoir to be sure it is full of clean water.

pH: The acceptable range of pH is 7 to 10. Water absorbs CO₂ and pH tends to reduce over time. Add sodium bicarbonate to raise pH if needed.

Cleanliness and Flushing: The water should be free of particles and biological growth. If there is substantial debris and biological growth, consider flushing the system.

To flush the system, follow the procedure below.

1. Check with the equipment manufacturer to confirm that hydrogen peroxide is approved for temporary use
 - a. If hydrogen peroxide is approved, continue to step 2
 - b. If hydrogen peroxide is not approved, disconnect the application and connect a short hose directly from the unit's supply connection to the return connections
2. Add 1 pint (0.5 L) of 3% hydrogen peroxide per every 15 gallons (57 L) of water to the tank
3. Circulate the solution for 20-30 minutes
4. Use the drain hose to drain the system
5. Refill the system with clean, potable distilled water
6. Repeat as necessary to fully flush the system

Glycol: If biological growth persists even after regularly changing the water and flushing the system, use laboratory/food grade (99% pure) propylene glycol to create a 10% mixture. Haskris recommends that additives be used only as a means of last resort.